

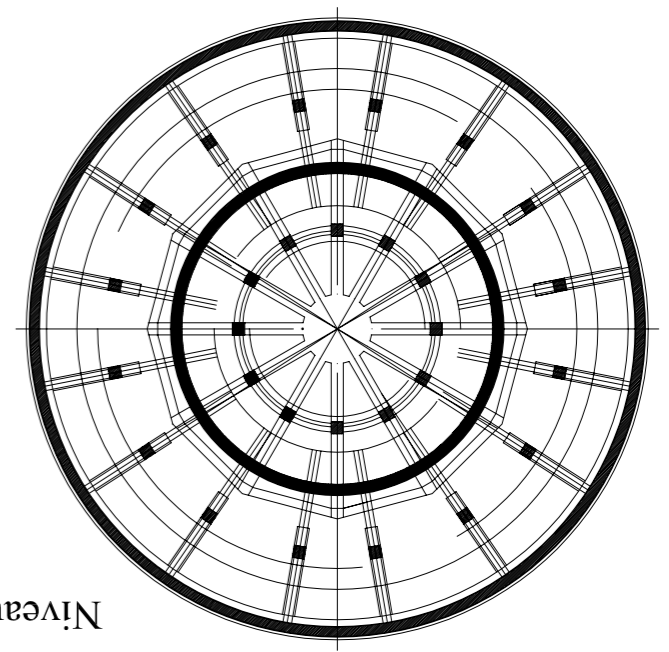

Plan du réservoir N-2

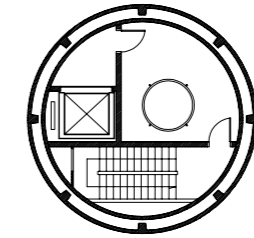

Niveau courant



Niveau bureaux N+7

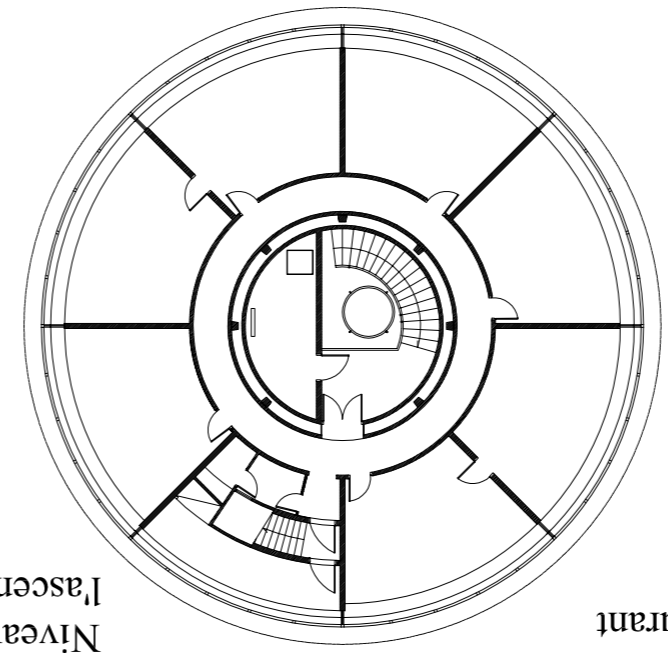

Niveau arrêt de l'ascenseur N+6

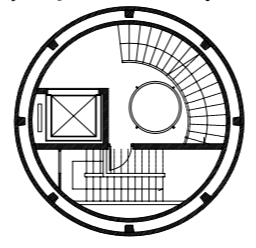

Niveau plateforme N+8

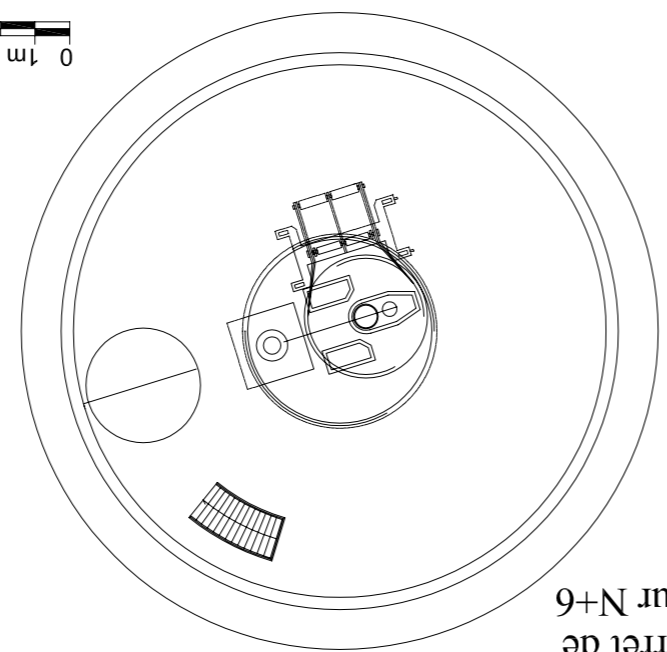

Plan du sous-sol N-1

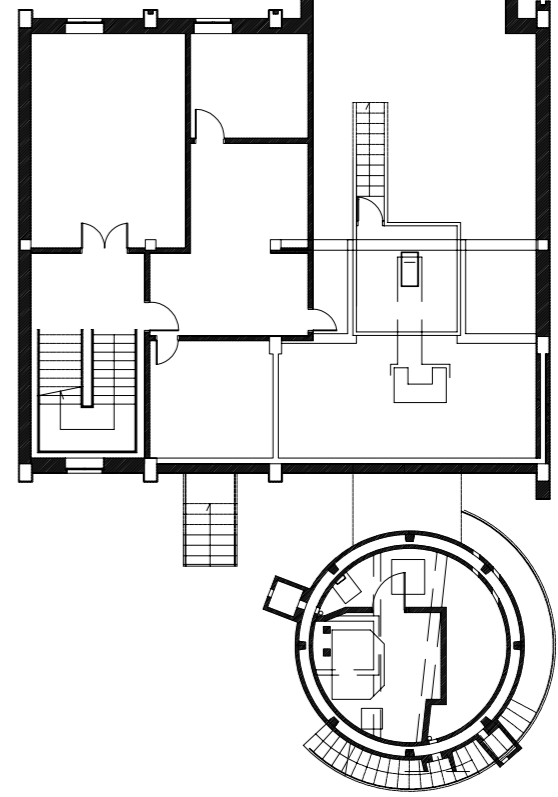

Plan du rez de chaussée N0

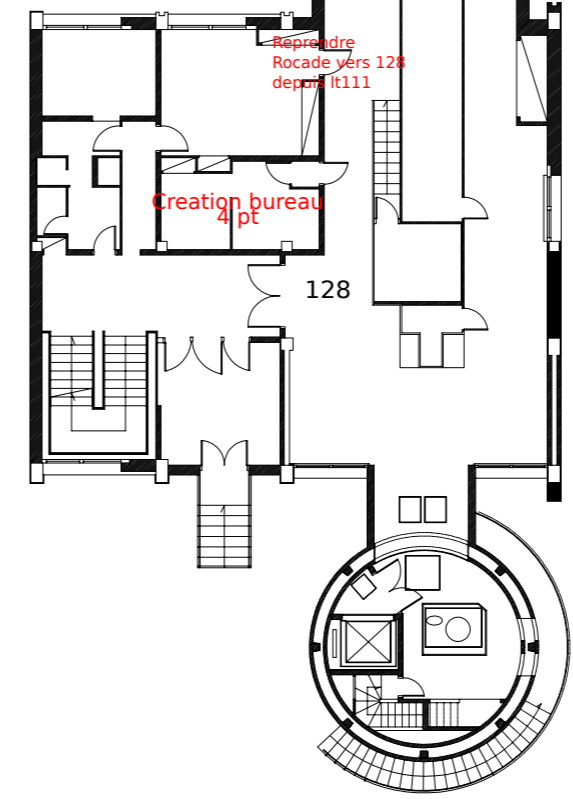

Plan étage N+1

